

# Simplex SGL Series Glycol Pump System

## Features:

- Polyethylene tank, includes cover
- Carbon steel tank stand, coated with enamel paint
- 1/4 HP Split-phase Pump Motor, single phase, 115 VAC, 5 amp
- 1/4 HP Pump, brass rotary vane type, optional 1/2 HP Pump available
- Thermal protected motor, 1,725 RPM, Insulation Class 8
- Control Panel, 115 VAC, in-line fuse
- Led indicator lights
- Side entry low level switch, 12 amp relay
- NPT Pressure Switch standard 10 psi cut-in, 40 psi cut-out
- Brass pressure relief valve 20-150 PSI
- 100 PSI Max Pressure
- 85° F Max Temperature
- Pressure gauge, strainer, isolation valve, pressure relief valve

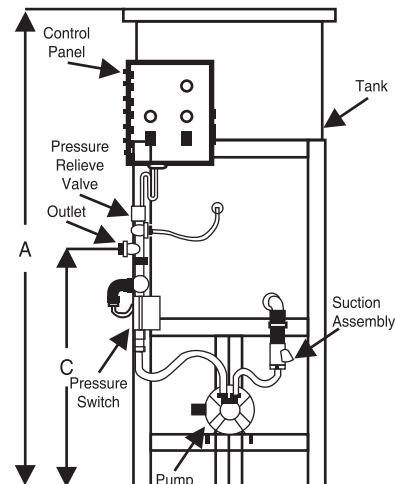
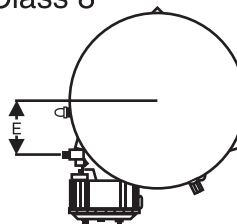

## Optional Features:

- 1/2 HP Split-phase Pump Motor, 115/60/1
- Alarm, 95 decibel, with a silence switch
- PLC interface remote dry contact on low level
- Float switch, high level, with remote dry contact (PLC interface)
- Stainless Steel cover, hinge, hardware
- Discharge Steel Manifold with high temperature hoses
- Tank Stand Mounted Mixer, fan cooled, totally enclosed, with control switch
- Pump motor, fan cooled, totally enclosed
- Outdoor rated, fan cooled, totally enclosed pump
- Solid cover, bolted to tank
- Expansion tank

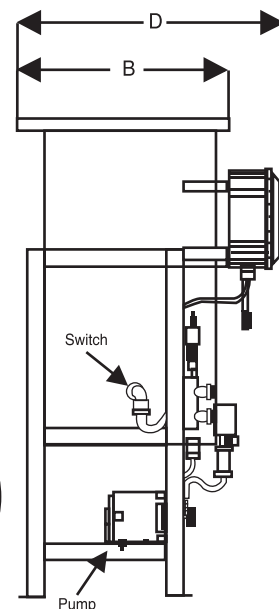
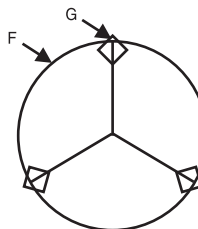

All packaging materials, thread protectors, plastic plugs and caps must be removed before installation.

Dimensions are subject to change without notice, please confirm actual dimensions with factory at time of order.

JOB NAME _____
LOCATION _____
_____
CONTRACTOR _____
CONTRACTOR P.O. NO. _____

ITEMS	QUANTITY
_____	_____
_____	_____
_____	_____
_____	_____
_____	_____

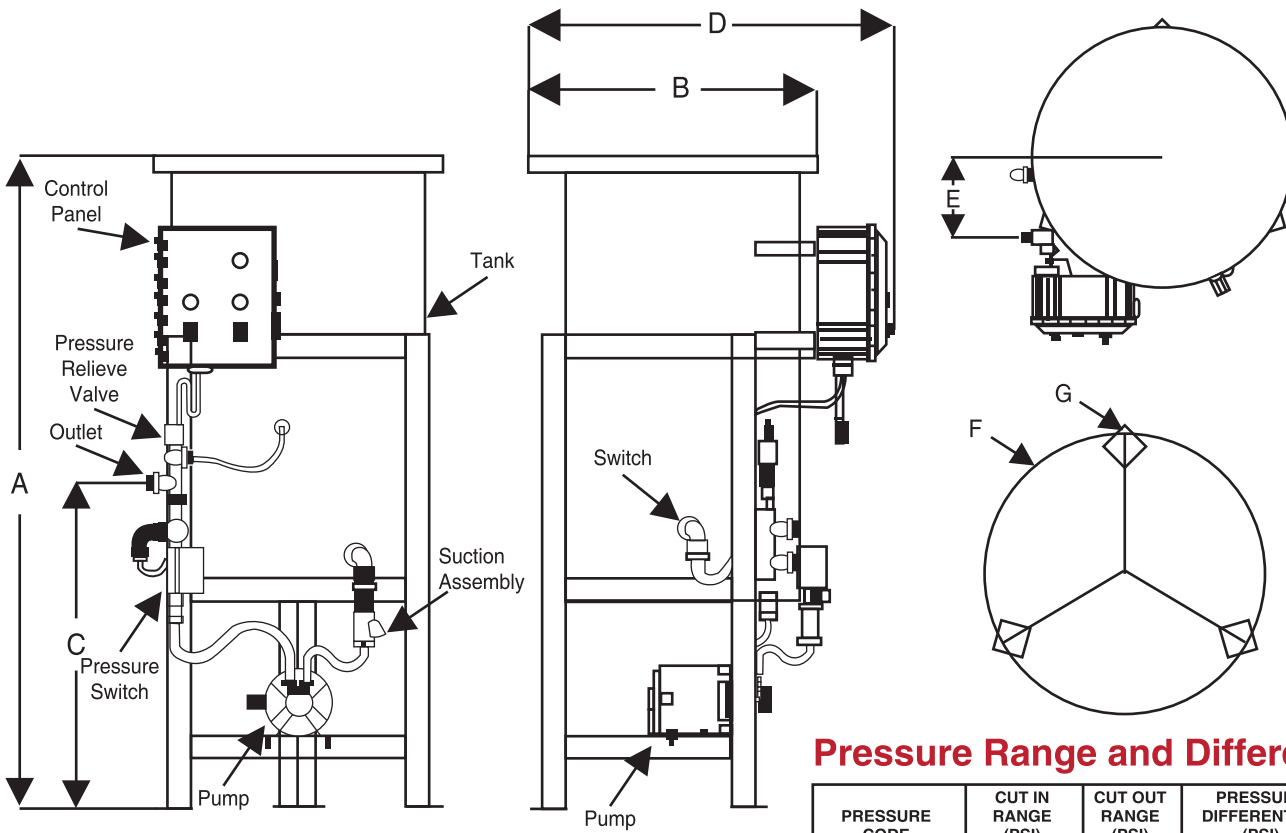

**Pressure Range and Differentials**

PRESSURE CODE	CUT IN RANGE (PSI)	CUT OUT RANGE (PSI)	PRESSURE DIFFERENTIAL (PSI)
STANDARD	10-45	20-60	10-30
OPTIONAL 1	40-80	65-100	20-40
OPTIONAL 2	3-10	9-30	6-20
DIGITAL	0-149	1-150	1-149

**Dimensions**

MODEL NO.	GALLONS	HEIGHT A (INCH)	PUMP WIDTH B (INCH)	OVERALL WIDTH C (INCH)	OUTLET TO BASE D (INCH)	OUTLET TO CENTER E (INCH)	DIAMETER F (INCH)	OUTLET G (INCH)	SHIPPING DIMENSIONS	SHIPPING WEIGHT
SGL-15-E-[ ]-[ ]	15	42 1/2"	17 3/8"	19 7/8"	25 1/2"	6"	20 1/4"	3/8"	31"X31"X50"	92 LBS
SGL-30-E-[ ]-[ ]	30	50 1/4"	20 5/16"	28"	28"	7"	23 5/8"	3/8"	31"X37"X56"	118 LBS
SGL-50-E-[ ]-[ ]	50	55 1/2"	24 7/8"	27 7/8"	31"	7 3/4"	27 1/8"	3/8"	31"X37"X62"	132 LBS
SGL-100-E-[ ]-[ ]	100	72 1/4"	30 3/8"	27 7/8"	36"	9"	32 1/8"	3/8"	38"X38"X70"	182 LBS

Standard 1/4 HP Pump  
Pressure vs Flow

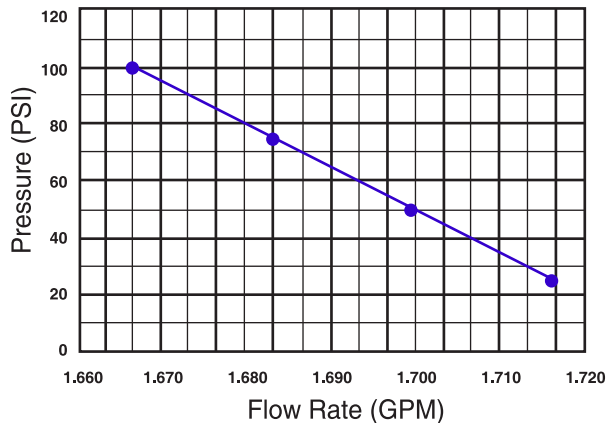

Optional 1/2 HP Pump  
Pressure vs Flow

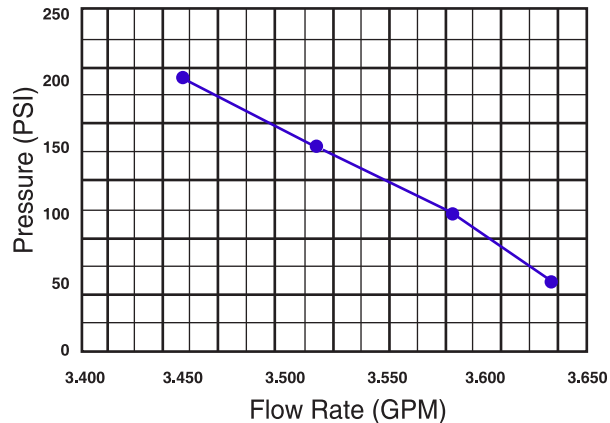

Dimensions are subject to change without notice, Please confirm actual dimensions with factory at time of order.